

K-BUS[®] IR Emitter & IR Learner

User manual-Ver. 1

BTIS-04/00.1

BTIL-01/00.2

KNX/EIB Intelligent Installation Systems

Contents

1. General	3
2. Technical data	4
2.1 The IR Learner	4
2.2 The PC Software	4
2.3 The IR Emitter	4
3. Dimension and Circuit diagram	5
3.1 Dimension diagram	5
3.2 Circuit diagram	5
4. Instructions for the PC software	6
4.1 Start window	6
4.2 Function configuration window	8
4.2.1 Channel	9
4.2.2 Group address area	9
4.2.3 Function address assignment area	10
4.2.4 Function area	10
4.3 Learning IR function	11
4.4 Build a new configuration file	14

1. General

We call it “IR Learning” that combine the three parts, PC Software, IR Learner and IR Emitter. The IR Learning can be used for learning control code of the IR Remote Controller, and storing the code to the database in the PC software. The learned control code can be stored, deleted or tested in the software.

The IR Emitter has 4 channels. Usually, we use one channel to control one IR Remote Control device. The IR Learning can learn up to 64 functional control codes for each channel.

The IR Learning is consist of PC Software, IR Learner and IR Emitter.

The PC Software is used for config the functions, like physical address, group address, scense call, etc.

IR Learner is connected to the PC via USB interface and used to learn the control codes of the keys of the IR Remote Controller. The learning process is realized by operating the software, and you should put the IR emitter on the remote control near to IR detector on the IR Learner as close as you can to avoid the failure of learning.

The IR Emitter is connected to the EIB/KNX bus directly using the EIB bus connection terminal. As the configuration has been finished, the PC software can download the learned control code to the IR Emitter via the KNX downloader, which has been connected to the KNX/EIB bus. After success to download, the IR Emitter can control the switch, wind speed and timing of a fan, as well as the IR remote control devices, such as DVD, TV, Air-Condition, Fan, etc. through sending telegrams on the KNX bus by other devices in the EIB/KNX system.

This manual provides detailed technical information about the IR Learning for users as well as assembly and programming details, and explains how to use the IR Learning by the application examples.

The functions of the IR Learning are summarized as follows:

- 4 channels
- Learning and storing up to 64 different IR functional control codes for each channel
- sending time and sending delay can be set for each control codes
- each main function can include 5 slave functions, this way is suitable for controlling several functions

via one object at a time

- You can set the emittion times and the delay time before sending for each function code.
- A channel can link up to 16 group addresses
- The IR functional control codes can be assigned to 1bit or 1byte type of object
- 1bit object can recall the control codes from all channels
- 1byte object can recall the control codes from its own channel
- The IR Learner uses a common USB port to communicate, it is easy to learn the functional control

codes of the IR remote controller and store the codes to the database of the PC Software

- Can learn more than 95% of remote controllers in the market

Each channel can take over all of the functions described above.

2. Technical data

2.1 The IR Learner

The design of the IR Learner is as a UDisk, small and exquisite in size. The IR Learner is needed to use only when it learns the functional control codes of the IR remote controller.

Attention: *When learning, please put the IR emitter on the remote control near to IR detector on the IR Learner as close as you can(within 3cm) to avoid the failure of learning.*

The IR Learner is provided with receiving and emitting IR function, so it can test and verify whether the learned control code has been learned correctly.

For convenient to operate, suggest that connect the IR Learner to PC via a USB extension cord please.

2.2 The PC Software

System requirements: windows XP or above operating system, don't need to install driver.

Operating environment: Install falcon, ETS3 or ETS4 software on your PC first, so the PC software can run directly and does not need to be installed. Meantime, there also need install Microsoft Office Access software on your PC, or you cannot configure functions.

2.3 The IR Emitter

The extremely compact design enables the IR Emitter to be inserted into a conventional 60 mm or 86mm wiring box.

Attention: *the Infrared emitter of the IR Emitter must be installed in range that the IR device can detect normally, to avoid no action.*

Power supply	Bus voltage	21~30V DC, via the EIB bus
	Standby current	<8mA
	Dynamic current	<20mA
	Power consumption	<240mW
Output	Channel Number	4 Channels
	Max. transmitting distance	2m
	IR wavelength	940nm
	IR emission&receiving angle	<45°
Operating and display	Red LED and button	For assignment of the physical address
	Green LED flashing	Indicate the device running normally (OK)
Connections	EIB/KNX	Bus connecting terminal (black/red)

	Infrared emitter cable	<10m
Temperature range	Operation	- 5 °C ... 45 °C
	Storage	- 25 °C ... 55 °C
	Transport	- 25 °C ... 70 °C
Mounting	Flush mounted	In wiring box, 60mm×60mm or 86mm×86mm
Dimensions	the IR Emitter	46mm×46mm×11.7mm
	the IR Learner	52.5 mm×18.1mm×9.3mm
Weight	0.05kg	

3. Dimension and Circuit diagram

3.1 Dimension diagram

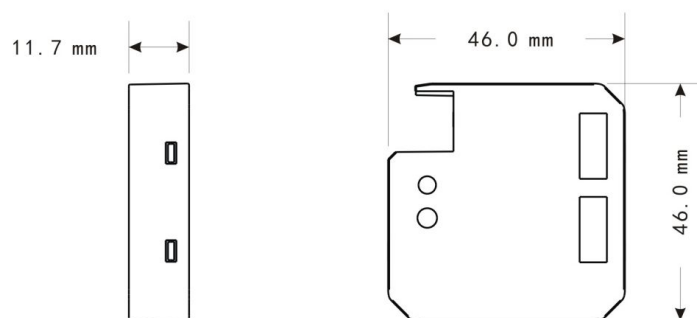

3.2 Circuit diagram

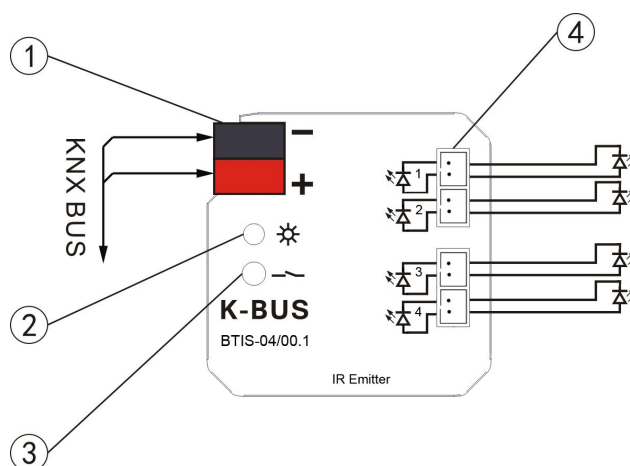

Fig.(1) IR Emitter (BTIS-04/00.1)

- ① KNX / EIB bus terminal
- ② Red LED for entering the physical address, green LED for application layer normally work

- ③ Programming button
- ④ Connectors for Infrared emitter cable



Fig. (2) IR Learner (BTIL-01/00.2)

- ① USB communication port
- ② IR detector. *When learning, please put the IR emitter on the remote control near to IR detector on the IR Learner as close as you can*

4. Instructions for the PC software

If you want to know all the functions about the IR Learning, you will need a PC which connect to EIB/KNX bus via KNX downloader , the IR Emitter which connect to EIB/KNX bus system via a KNX interface, and the IR Learner which connect to the PC via a USB port, and run the PC software to learn and configure the functions of the IR remote control device , and download these functions to the IR Emitter.

4.1 Start window

Start the program “GVS KNX Tool.exe” in the directory “Knx_IRTool2”, the software operating window is shown as fig.1.

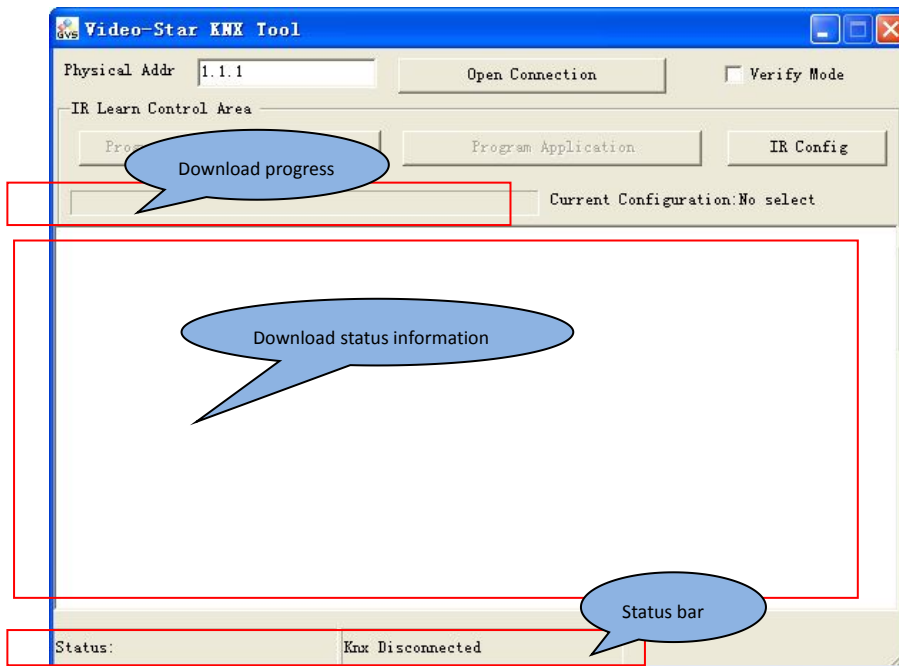

Fig. 1 Start window

Physical Addr: Here can be used to set the physical address for the IR Emitter, the format is xx.xx.xxx

Open connection: Click this button, the ETS connection manager window will visible, shown as fig.2. Here can configure the KNX communication interface, such as USB, RS.232 standard, RS.232 FT1.2, IP(EIBlib/IP), KNXnet/IP, KNXnet/IP Routing, it is similar to the ETS tool software. The KNX communication interface that you select must match the interface of the downloader to be connected in the EIB/KNX bus system, otherwise the PC software can not connect to the EIB/KNX bus system. After configuring successfully, the status bar displays “**KNX Tool Connected**”.

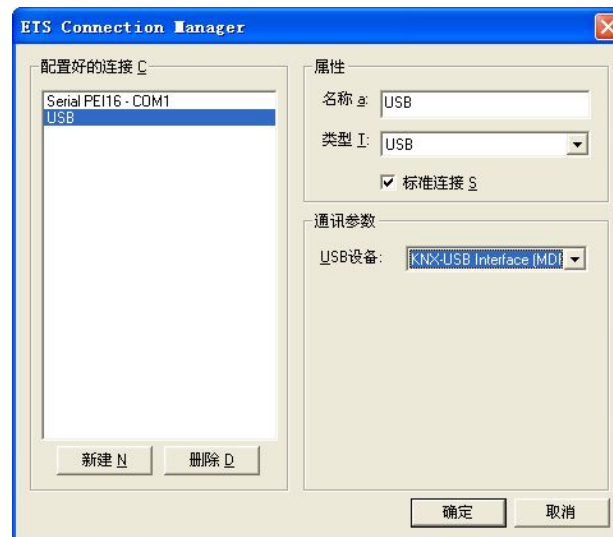

Fig.2 ETS Connection Manager

Before the PC software has not been configured the KNX communication interface yet, the button “Program Address & Application” and “Program application” are shown gray and can not use, and the status bar displays “**KnX Disconnected**”, and vice versa.

Program Address & Application: This button is used to program the physical address and download the application for the IR Emitter. When programing the address, the software will prompt you to press the programming button of the IR Emitter. After pressing the button, the red LED is on.

Program application: This button is only used to download the application. When we do not need program the physical address, we can push this button to download application for timesaving.

IR config: Click this button, the load configure window will appear, shown as fig. 3. Here is a list of configuration files, and at least has one record, otherwise appear a alarm shown as the down-right figure. Select a configuration file and click the “Load” button, the corresponding function configuration window will appear, shown as fig. 4. If Click the “Cancel” button, the software will back to the window of the first configuration file. When import other configuration file, the information will be updated in the group address area and the function area immediately.

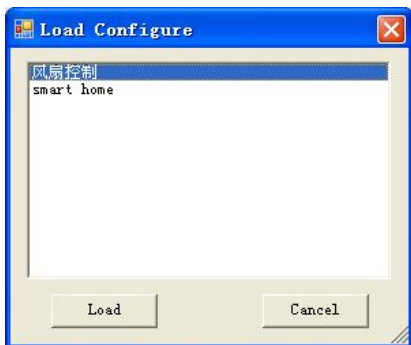

Fig. 3 List of configuration files



Alarm: At least keep one record

4.2 Function configuration window

The function configuration window is shown as fig. 4. Here you can assign a group address to a learned IR remote control function. Via the group address the IR Emitter can communicate with other devices on the bus. Meanwhile, you can recall these functions via 1bit or 1byte datapoint type.

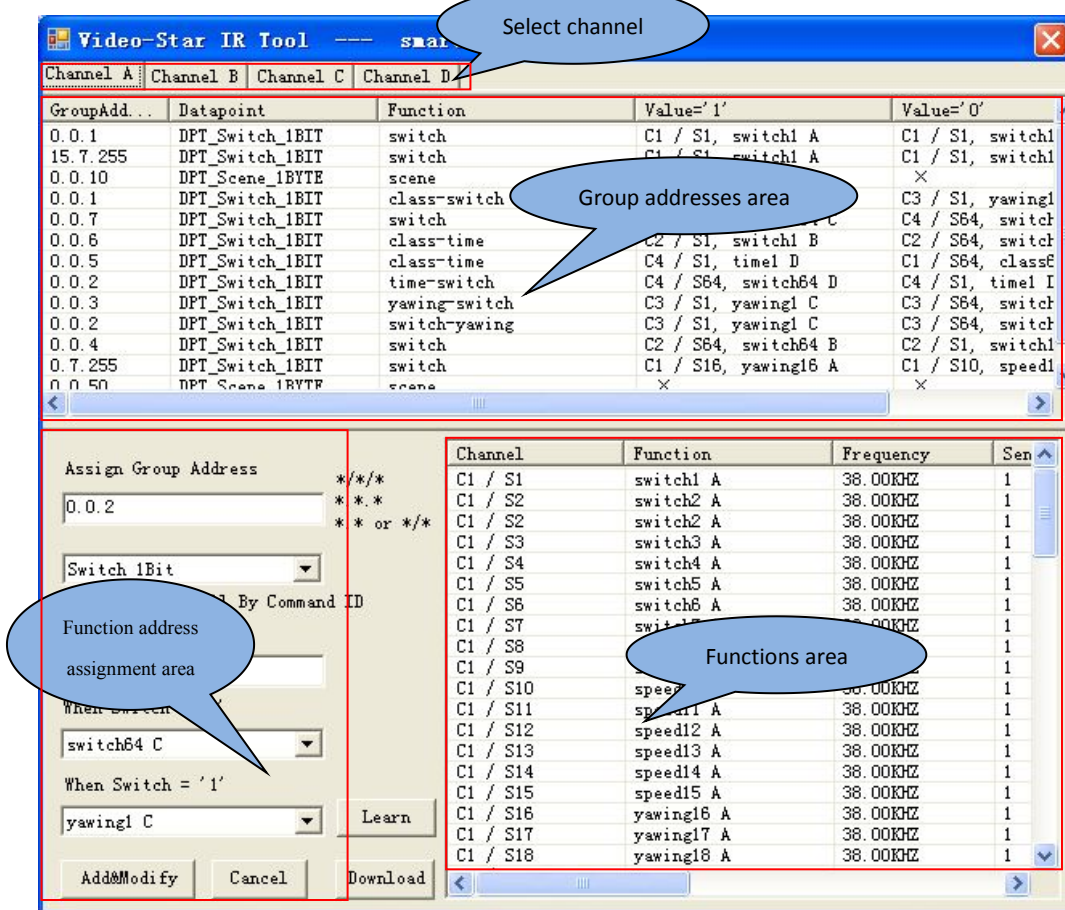

Fig. 4 The function configuration window

4.2.1 Channel

You can view the functions of current channel via selecting the corresponding channel or give the channel configurate functions. Each channel can be assigned 16 group address at most, and the channels are independent each other. If assign exceeds 16 group addresses to a channel , the error as follow will appear:



4.2.2 Group address area

Here shows the detail information of each group address, such as function, datapoint type, etc. These information can be configurated in function address assignment area. Clicking the right mouse button in the group address area, the menu command as follow appears:

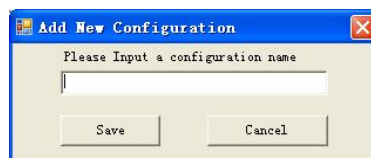
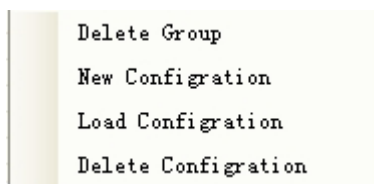

Fig. 5 New configuration file

Delete group: To delete selected group address.

New configuration: This command is used to add a new configuration file, as shown fig. 5 dialog box, prompting you input the name of a configuration file. After save, a blank function configuration window will appear, as shown fig.4, but there is no data on the function area and group address area. Here can add up to 16 configuration files.

Load configuration: This command is used to load a configuration file, as shown on fig. 3. You can select the file in the list to import.

Delete configuration: To delete the current configuration file.

The title bar in the group address area:

Groupaddress: Display the group address of functions.

Datapoint : Display the datapoint type of recalling functions , DPT_Switch_1BIT or DPT_Scene_1BYTE。

Function: Function description or object function name.

Value='1': It is available if the datapoint type is DPT_Switch_1BIT. When the object receives a telegram "1", the corresponding function is recalled.

Value='0': It is available if the datapoint type is DPT_Switch_1BIT. When the object receives a telegram "0", the corresponding function is recalled.

Scene: It is available if the datapoint type is PT_Scene_1BYTE. When the object receives the scene number, the corresponding function is recalled.

Sign "×" means that the datapoint type is not recalled or the function has been deleted in the function area. Sign "√" means that the functions are recalled via scene.

Cx/Sx,XX, Cx — Channel number, Sx—Scene number, XX—Function description in the function area.

4.2.3 Function address assignment area

Here you can assign a group address to each function, and you can also set the datapoint type of object as 1bit or 1byte. **Main configuration parameters as follows:**

Assign group address: In this textbox you can assign a group address to the IR control functions in the function area. There is the group address format on the right side, it conforms to the KNX standard.

Datapoint: In the option box you can select "switch 1bit" or "scene 1byte". If selecting "switch 1bit", you can recall different functions from all channels via the 1bit object receiving a telegram "0" and "1". If selecting "scene 1byte", you can only recall different function from the current channel via 1byte scene object, **scene number 1~64 corresponding to telegram 0~63.**

Object function: To name the object function will be recalled.

When switch = '0': If "switch 1bit" is selected in the datapoint, the option box is visible. Here you can select a function to be recalled when the object receives a telegram "0". All functions in the function area are visible in the option drop-down box.

When switch='1': If "switch 1bit" is selected in the datapoint, the option box is visible. Here you can select a function to be recalled when the object receives a telegram "1". All functions in the function area are visible in the option drop-down box.

When these parameters have been finished configuration, clicking the button "Add&Modify", then the configuration information will be added to the group address area. In the group address area via double-clicking an object, the name of object function can be modified in the function address assignment area.

Via clicking the button "Cancel" back to start window, as shown on fig. 1.

4.2.4 Function area

Here list all learned IR remote control function, the channel and scene of the function, IR

transmitting frequency, pulsecount, send times and slave function. In the function address assignment area you can assign a group address to each function. Clicking the right mouse button in the function area, **menu command as follow appears:**



Add new: To add a new function, as shown on fig.6.

Modify: To select the function to be modified, then you can modify description of the function, send times, current detect, send delay and slave command list , but can not modify the main channel and main scene as well as the IR learned control code.

Show: To select the function to show, then you can see the detail information of the function.

Delete: To select the function to be deleted. If click it the tips as follow will be popued, you can chose to delete or not to delete the function.

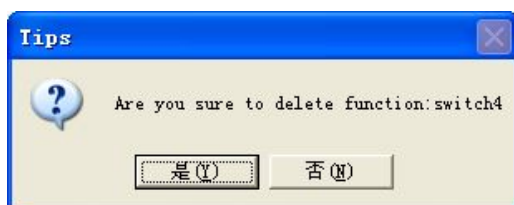

The title bar in the function area:

Channel: Channel and scene number, like C1/S2

Function: Function description of a learned IR remote control code

Frequency: IR transmitting frequency

Sendtime: IR transmitting times

Plusecount: IR pluse number

Attachcmd: slave function

All information in the function area can be configured in fig.6. Each function can be configured 64 functions at most, so there are Max. 256 functions in the function area for 4 channels. Meanwhile, each main function can attach up to 5 slave functions which scene number must not to be the same as the main function's.

4.3 Learning IR function

To learn the control code of common function of IR remote control, as shown on fig. 6. Here can learn and configure all information for the function area via a IR Learner. Clicking the button

“Learn” in fig.4, you will open the following window, and learning the functions of IR remote control.

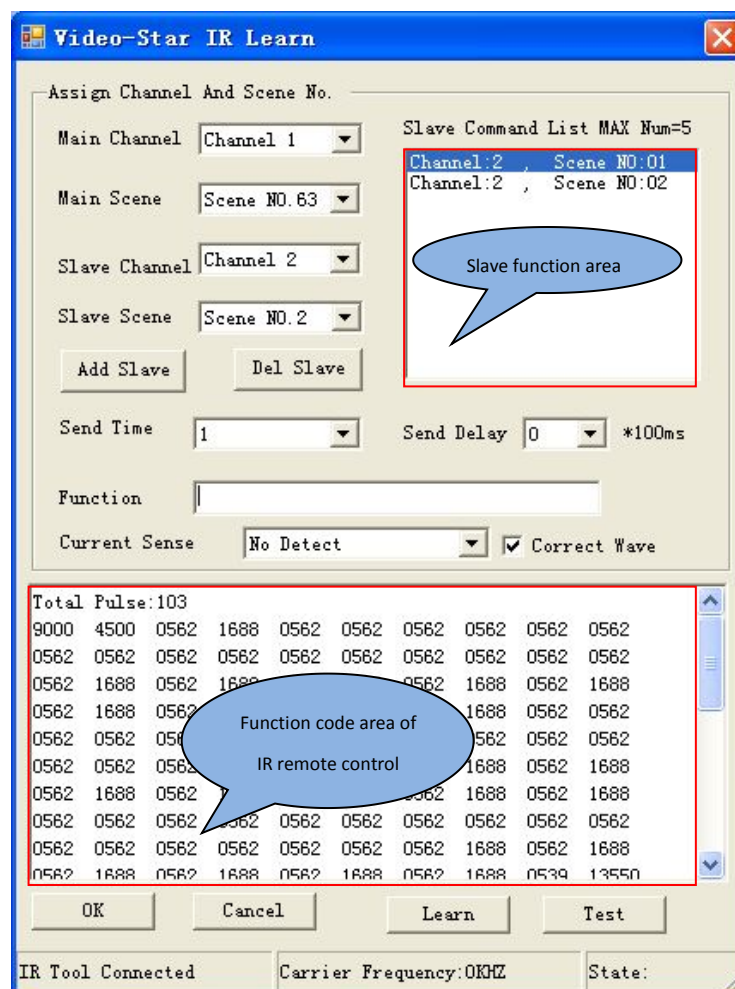

Fig. 6 Learning IR remote control function window

The step that the IR learner learns a function of the IR remote control is as follows:

1. **Learning:** Click the button “Learn”, right now the button becomes “Learning”, then put the IR detector of Remote Controller as near as possible to the IR detector of the IR Learner, and press the function key of the IR remote control, then in fig.6 the function code area will display the control code information of the function key, such as frequency, pulse count. Meanwhile, the button “Learning” changes back to “Learn”.
2. **Test:** To test the control code information of the function key, and ensure that it is effective. Now you need to place the IR detector of the IR Learner in areas that the IR device can detect normally, and to click the button “Test”. If the IR device has action, and the action is the same as the function of the key, that means the IR Learner has learned

successfully the function of the key. If the IR Learner does not successfully learn, you need to repeat the above process.

3. **Configuration:** To config the parameters, such as channel, scene number, slave function, send time, send delay and function description, etc. of the control code information of the function key. After finished configuring well, to click the “OK” button, the software will back to the window of the function configuration, and the information of the function key is saved to the function area. If clicking the “Cancel” button, the software will also back to the window of the function configuration, but the information of the function key is not saved .

In fig .6 Main configuration parameters as follows:

Main channel: To assigns a channel to the function of a key.

Main scene: To assigns a scene number to the function of a key.

Slave channel: To select a channel for a slave function.

Slave scene: To select a scene number for a slave function.

Add slave: when a slave function has been assigned a channel and a scene number, you can add the slave function to the slave function area via this button. Each main function can attach up to 5 slave functions, and the 5 slave function can be found in the function area, otherwise no action. For example, you want to turn on a fan and let it pivot, then when you configure a “on” function, you can attach a “pivot” function, and meantime you can also attach an open TV function, etc. but the “pivot” function and the open TV function also need to be learned in advance via the IR Learner and saved to the function area.

Del slave: To select the slave function to be deleted in the slave function area, and click the button, then the slave function is deleted.

Send time: To select the send times , for example, the wind speed function of a fan is set to 2 times for transmitting, then when the IR Emitter receives a corresponding telegram, the IR Emitter will send the wind speed signal to the fan and repeat 2 times, then the wind speed of the fan will jump 2 steps.

Send delay (*100ms) : To set the send delay for the control code of a function (referred to as function signal). For example, you turn on a fan, and attach a pivot and time function. If they are executed at the same time, this may influence the life of the fan motor, so you can delay a period of time for transmitting of the pivot and time function. Then when the IR Emitter receives a corresponding telegram, the IR Emitter will first send the turn on function signal to the fan, after a while send the pivot function signal to the fan, and then after a time send the time function signal to

13

the fan, in order to protect the motor of the fan.

Function: To give a learned IR remote control code add Function description

Current Sense: Before sending the function code, the IR Emitter whether detects the current on the IR device. There are three type:

No Detect: The IR Emitter will not detect the current of the IR device when it receives a corresponding telegram, and it will send the corresponding function directly to the IR device.

No Current to send: The IR Emitter will detect the current of the IR device when it receives a corresponding telegram, if there is not current, it will send the corresponding function to the IR device, vice versa.

Have Current to send: The IR Emitter will detect the current of the IR device when it receives a corresponding telegram, if there is current, it will send the corresponding function to the IR device, vice versa.

For example, The current sense is used for controlling a TV. Due to turn on or turn off the TV, it uses the same control code. Now you want to turn on the TV, and the current sense is selected with “No Current to send”, if the TV has been turned on, it will no action (or else turn off the TV). Now you want to turn off the TV, and the current sense is selected with “Have Current to send”, if the TV has been turned off, it will no action (or else turn on the TV).

Attention: current version has not supported this function, so select “No Detect” please.

Correct wave: To correct waveform of the code, for NEC, Philips, Panasonic, Sony and other code, correcting them to theoretical cycle and duty cycle, to reduce the error in the learning process. By default, the parameter is selected. If the test of the code can not pass when the correct wave is selected, you need to cross out the option, and then learn the code again.

4.4 Build a new configuration file

The main steps that build a new configuration file as follows:

1. The IR Learner is connected to a PC, the IR Emitter is connected to the EIB/KNX bus system, start the PC software and come to start window, set the KNX communication interface and connect.
2. Open a default configuration file, enter the function configuration window. Click the right mouse button in the group address area, select **new configuration** to build your own configuration file.
3. Click the button “Learn” in function address assignment area, enter the learning IR function window, here you can learn your required function and test it, if test OK,

configure relevant parameters to it, see chapter 4.3. Save the function via clicking the button “OK” and the software will back to the function configuration window.

4. In the function configuration window, assign a group address ,communication type, and so on to a learned IR function. After configuring well, click the “download” button, the software will back to the start window.
5. In the start window, assign a unique physical address to the IR Emitter, and then program it and download the configuration file (program application) to the IR Emitter.
6. After finish above steps, send a corresponding telegram to the IR Emitter via other bus devices. When the IR Emitter receives the telegram, it will send the relevant function to the IR device, and the IR device will execute the corresponding action.

Attention:

- 1、 **For current version, due to have not import/export configuration file function yet, you have better back up the “.mdb” file on the program path in advance, to avoid lost the configuration files in the software by incaution delete.**
- 2、 **Don’t send telegram to the IR Emitter frequently, or the telegram cannot be recognized and cannot respond to the bus on time by IR Emitter, and lost.**